

JP / JP PM JP PT-V / JP PT-H

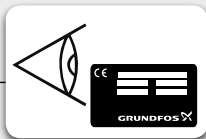

be
think
innovate

GRUNDFOS 



Min./Max. 0/40 °C (S3: 60 °C)
Min./Max. 32/104 °F (S3: 140 °F)



$P_{max} = 6 \text{ bar (87 psi)}$



• Voltage [V] • Connection:
• Frequency [Hz] GAS / NPT

Min./Max. 0/40 °C (S3: 55 °C)
Min./Max. 32/104 °F (S3: 131 °F)



JP



JP

Max. 8 m / 26 ft

≥ 0.5 m / 1.64 ft

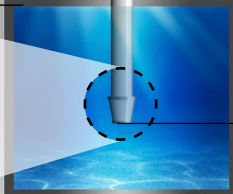
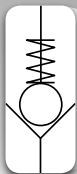
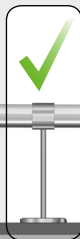
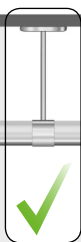

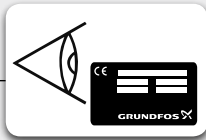

Min./Max. 0/40 °C (S3: 60 °C)
Min./Max. 32/104 °F (S3: 140 °F)



$P_{max} = 6 \text{ bar (87 psi)}$



- Voltage [V]
- Frequency [Hz]
- Connection: GAS / NPT

Min./Max. 0/40 °C (S3: 55 °C)
Min./Max. 32/104 °F (S3: 131 °F)



JP PM



$P_{start} = 1.5 \text{ bar (22 psi)}$

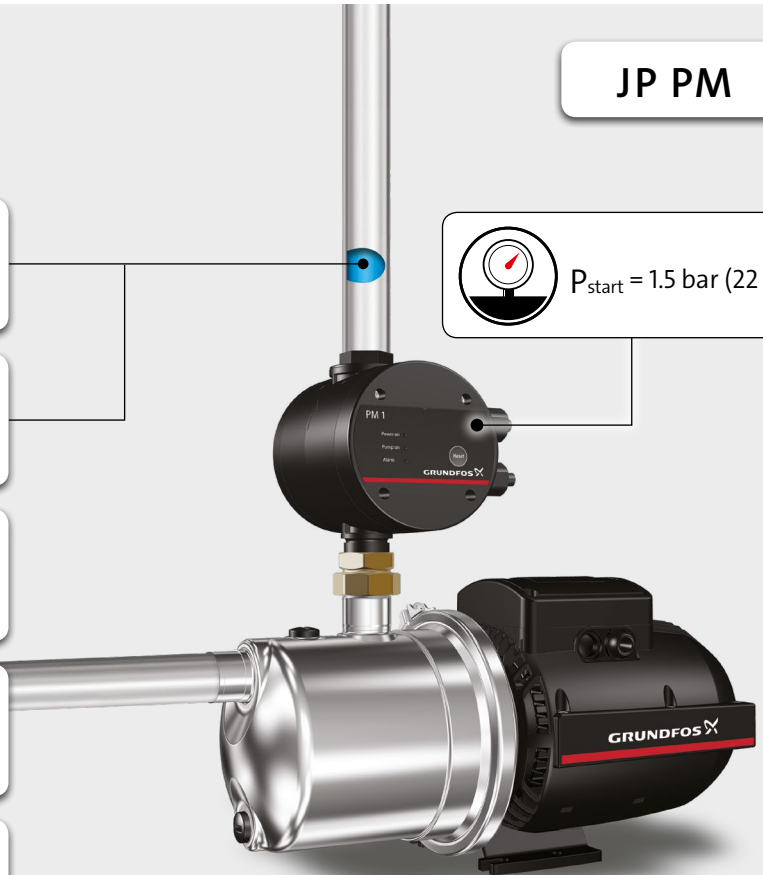

JP PM

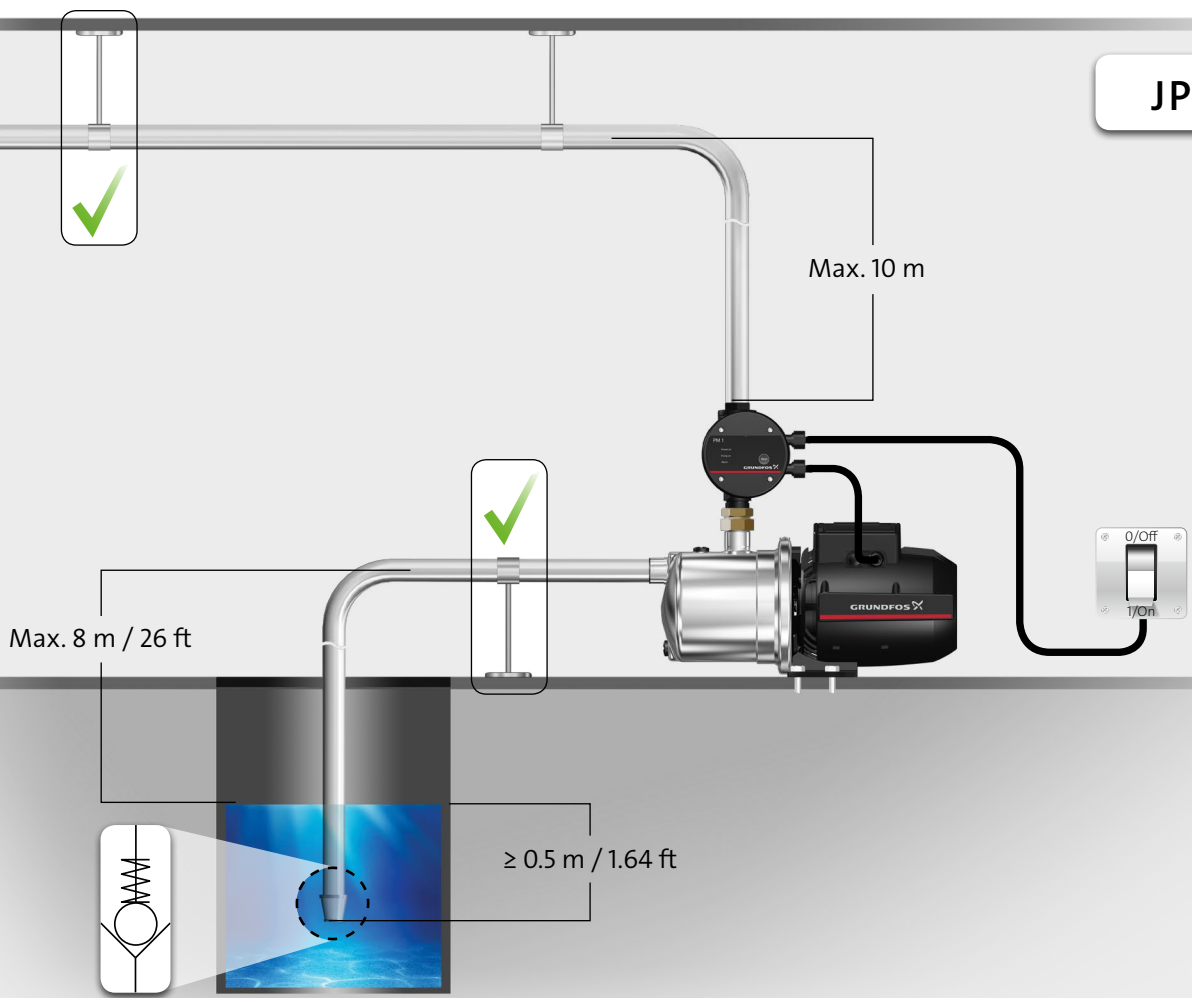

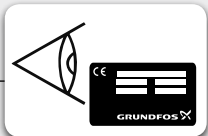

Min./Max. 0/40 °C (S3: 60 °C)
Min./Max. 32/104 °F (S3: 140 °F)



$P_{max} = 6 \text{ bar (87 psi)}$



• Voltage [V] • Connection:
• Frequency [Hz] GAS

Min./Max. 0/40 °C (S3: 55 °C)
Min./Max. 32/104 °F (S3: 131 °F)



JP PT-V

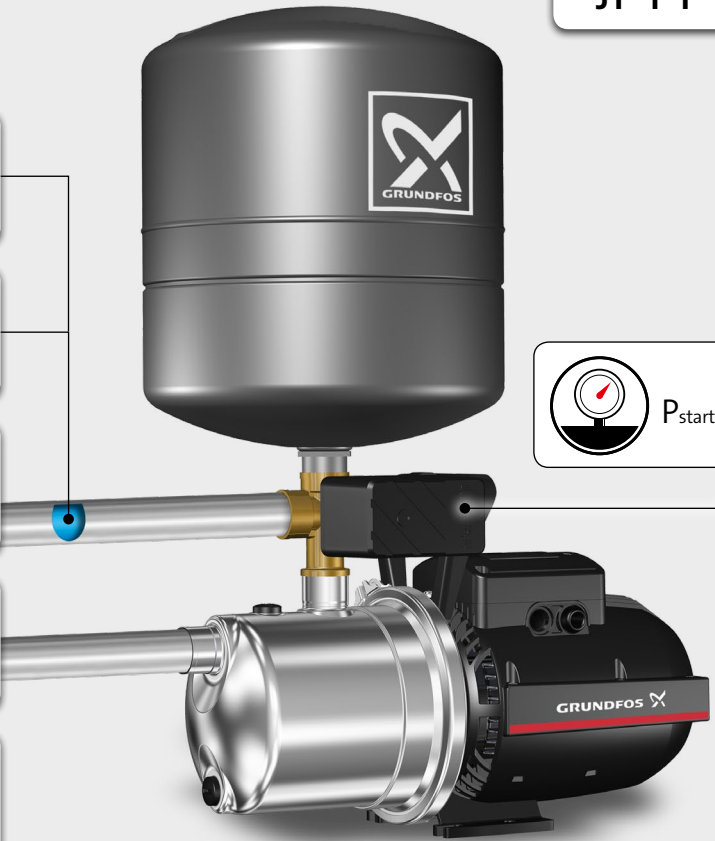

$P_{start} = 2.2 \text{ bar}$

JP PT-V

(32 psi)

Max. 8 m / 26 ft

$\geq 0.5 \text{ m} / 1.64 \text{ ft}$

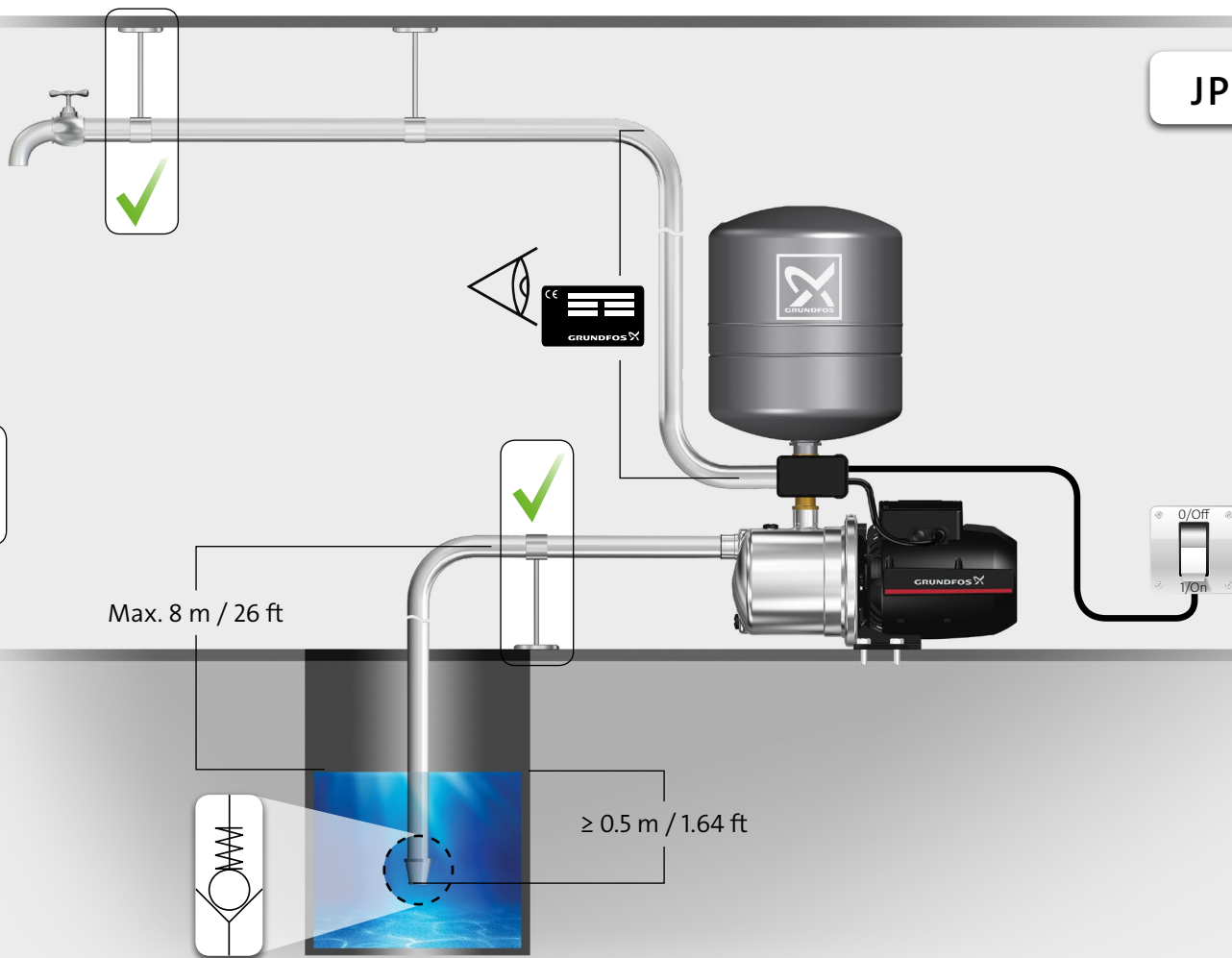

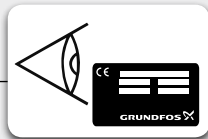

Min./Max. 0/40 °C (S3: 60 °C)
Min./Max. 32/104 °F (S3: 140 °F)



$P_{max} = 6 \text{ bar (87 psi)}$



• Voltage [V] • Connection:
• Frequency [Hz] GAS

Min./Max. 0/40 °C (S3: 55 °C)
Min./Max. 32/104 °F (S3: 131 °F)



JP PT-H

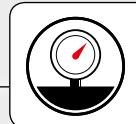

$P_{start} = 2.2 \text{ bar}$

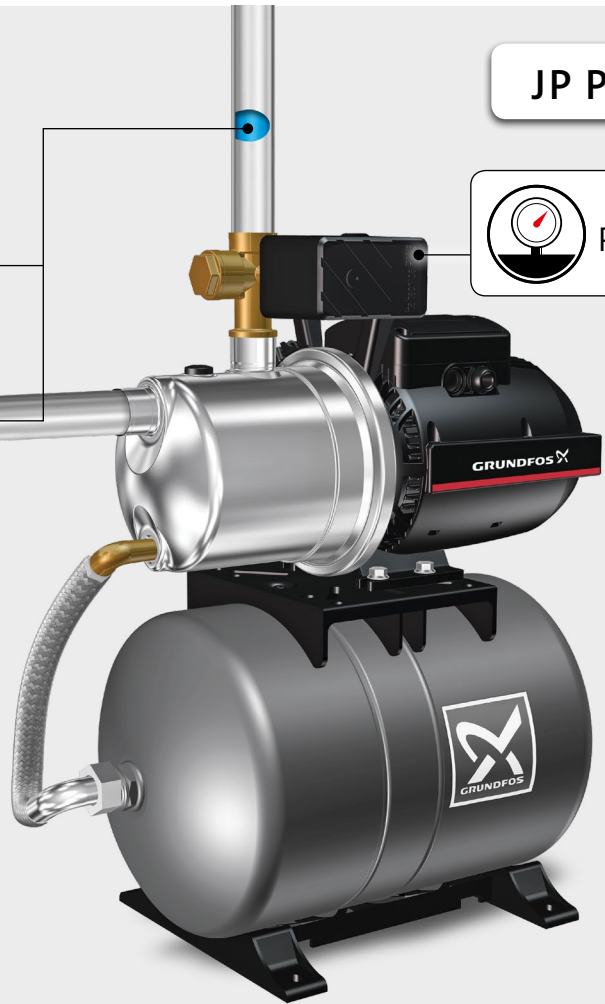

JP PT-H

(32 psi)

Max. 8 m / 26 ft

≥ 0.5 m / 1.64 ft

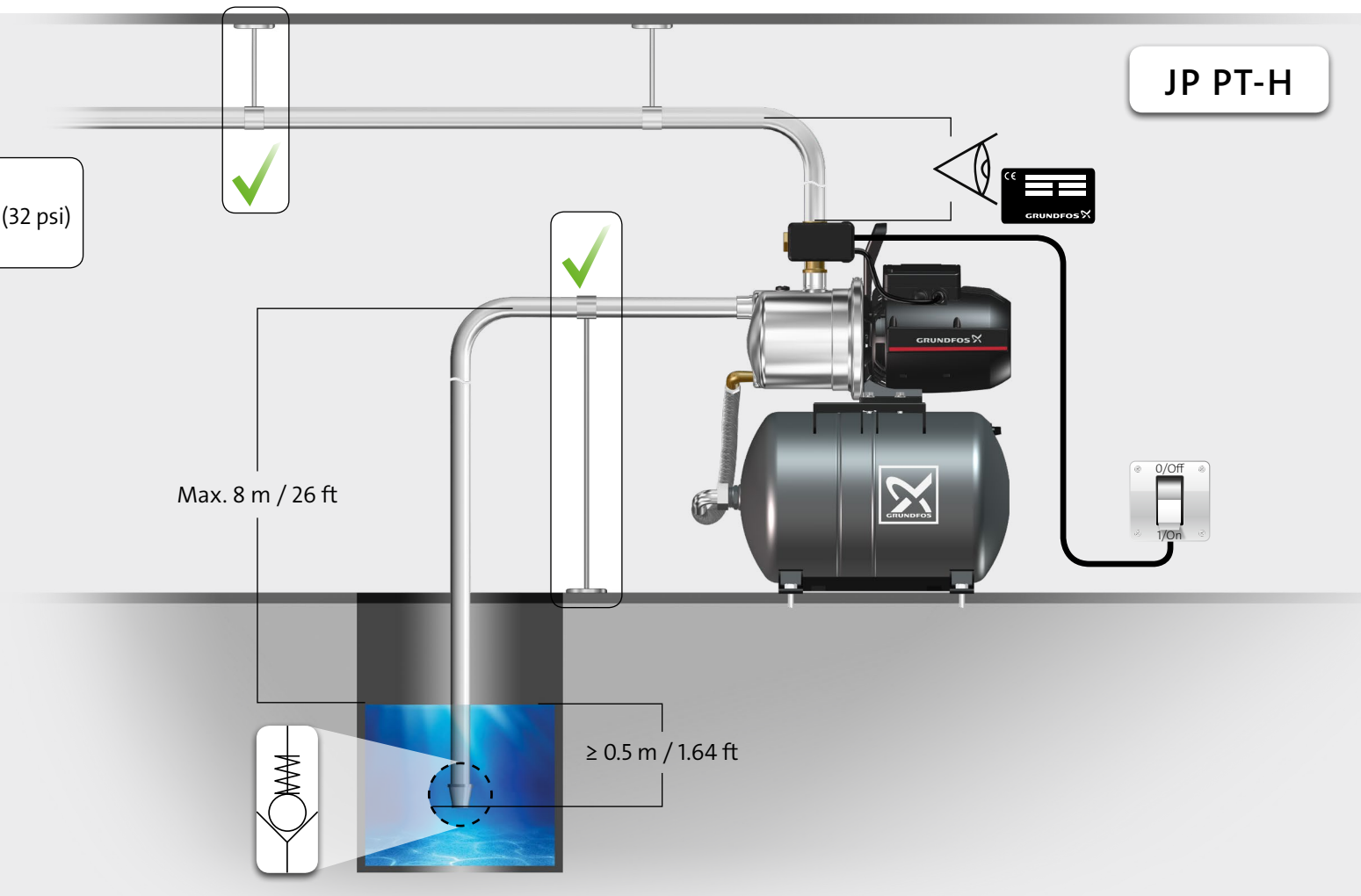

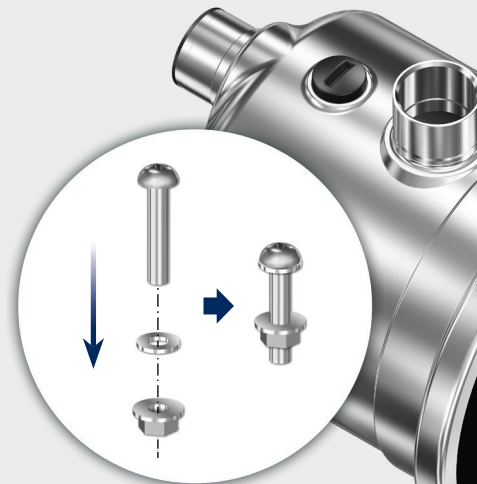
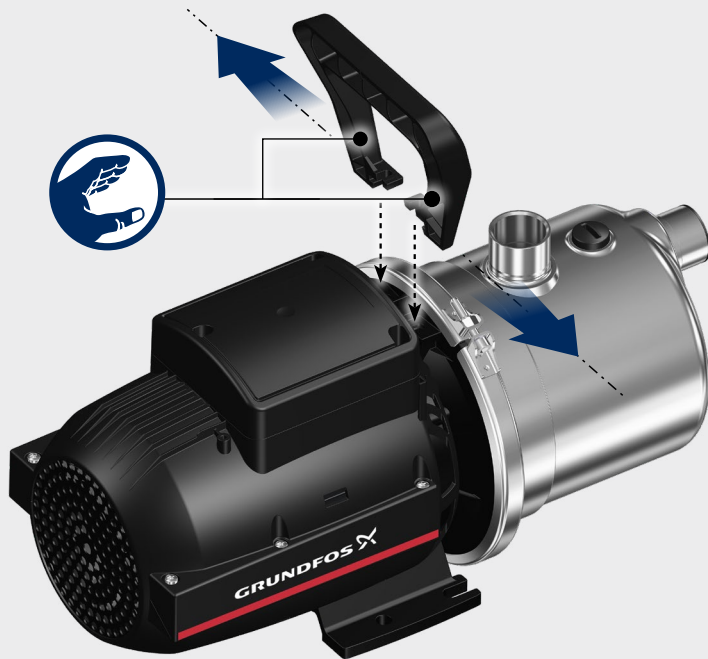
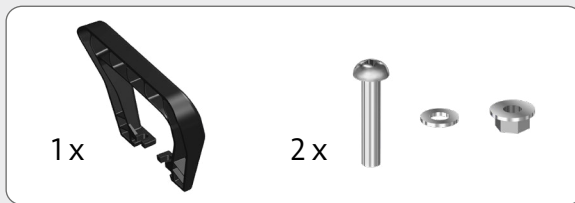

JP

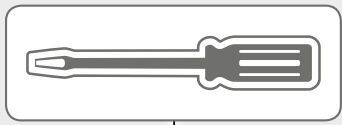

1A

JP / JP PM/ JP

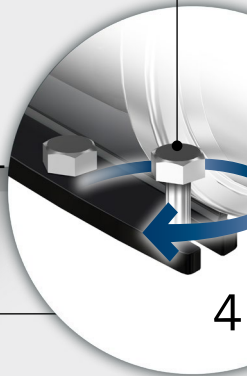
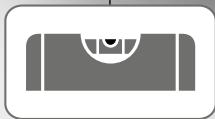
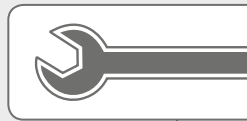
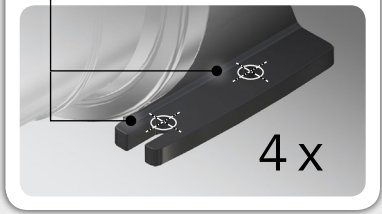
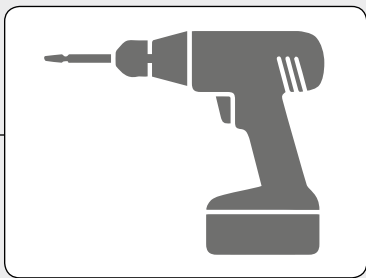

PT-V

1B

JP PT-H

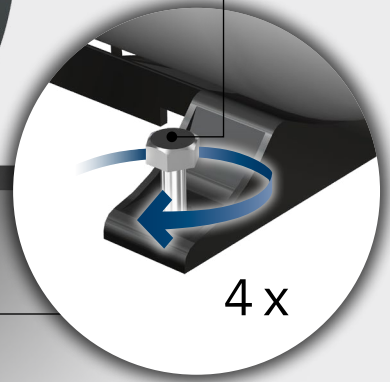
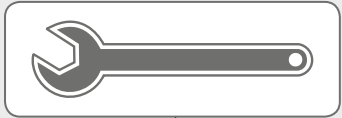



2a

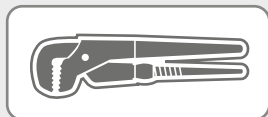
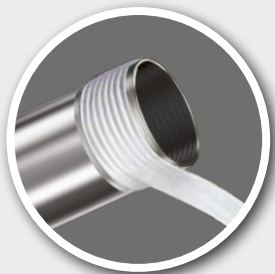

JP

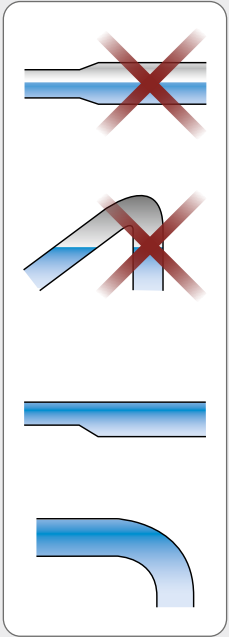

2b

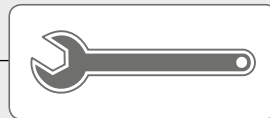
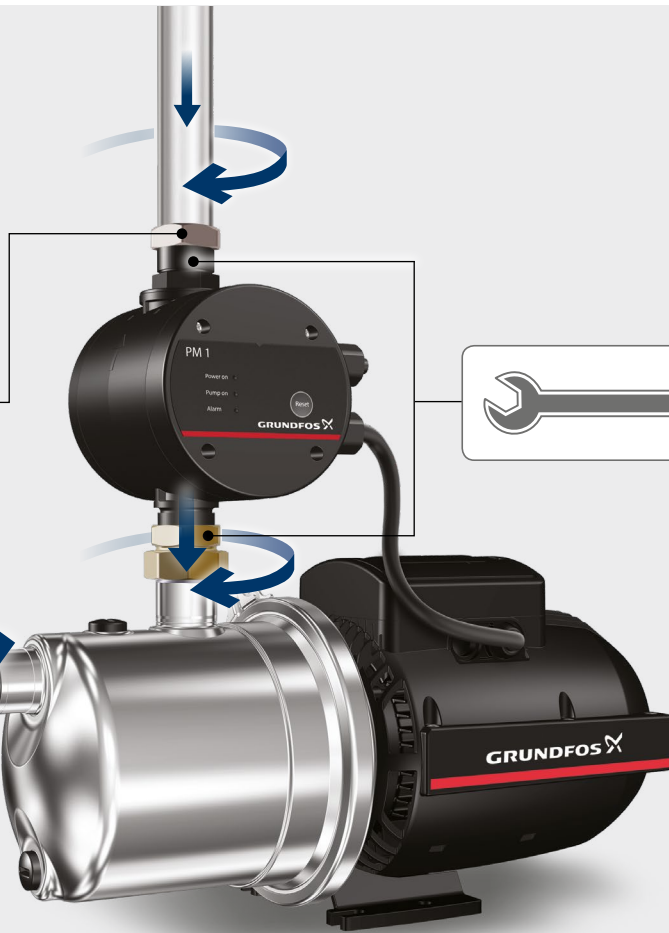
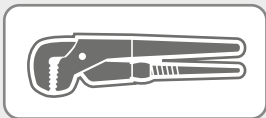
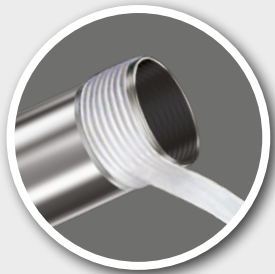

JP PM

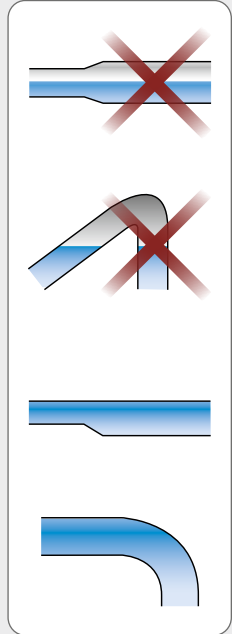

2c

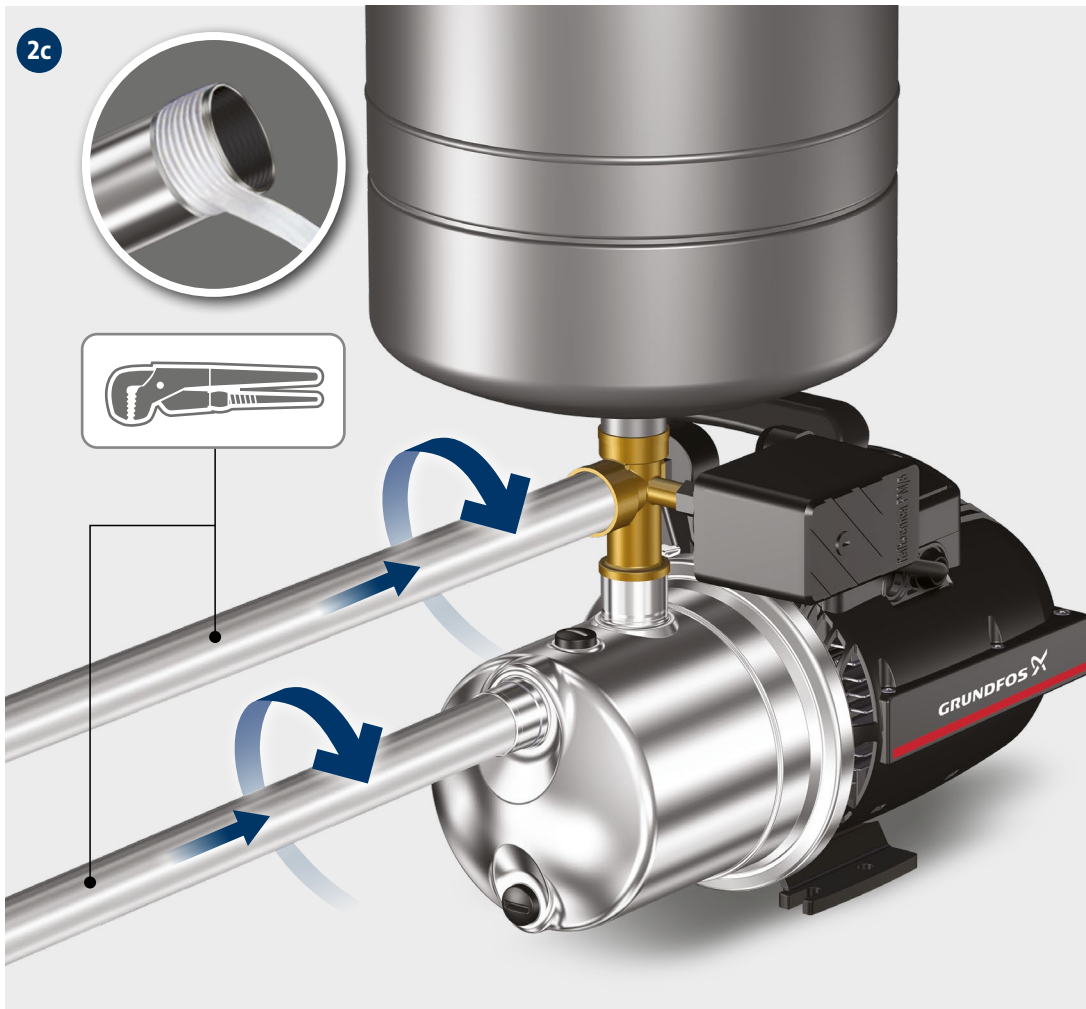
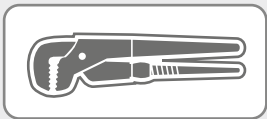
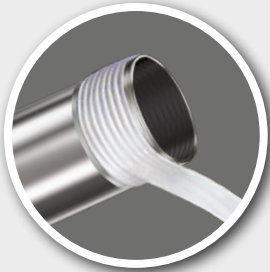

JP PT-V

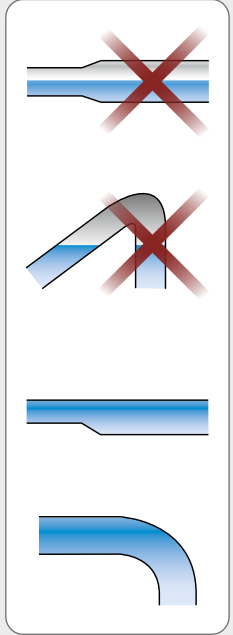

2d

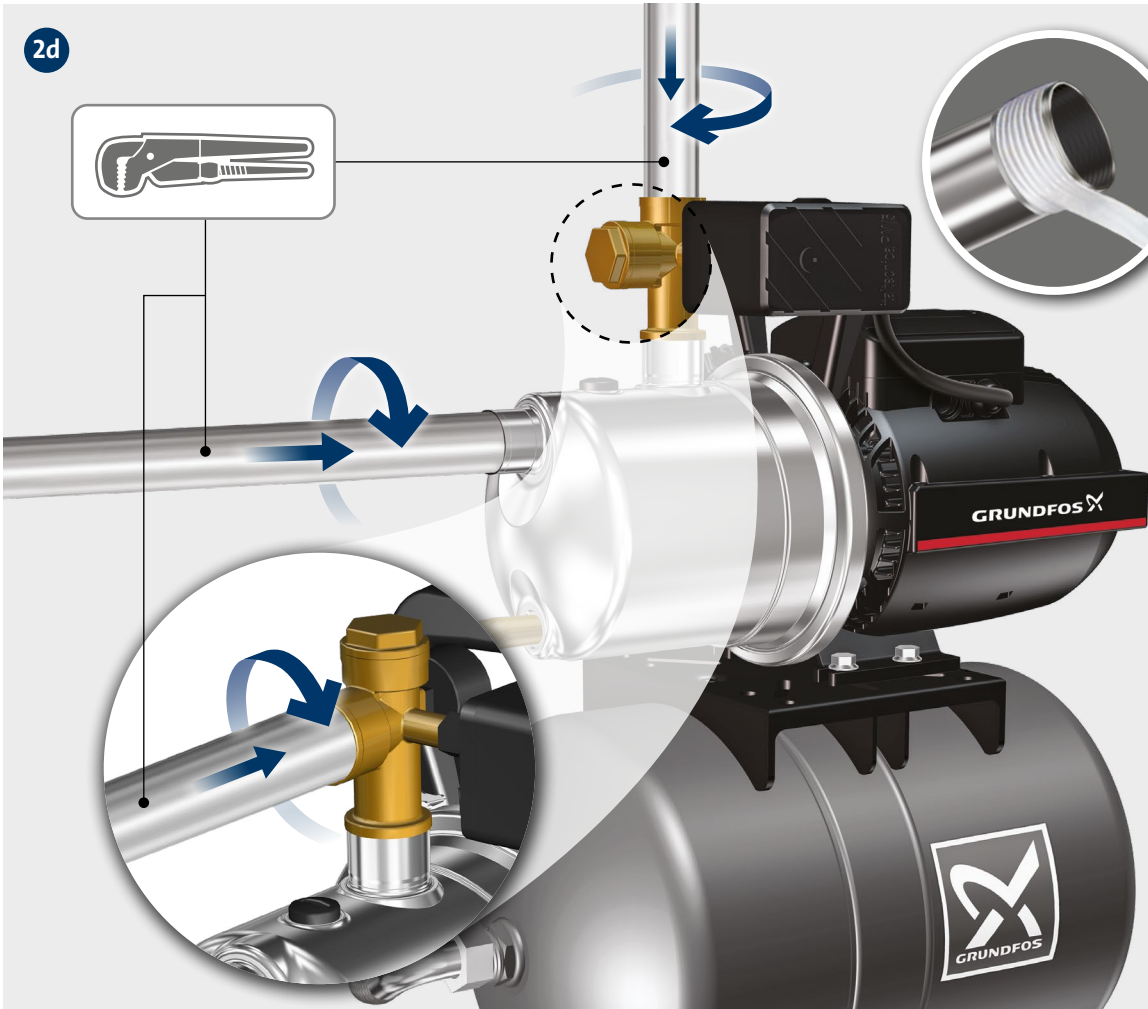
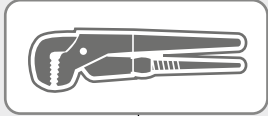

JP PT-H

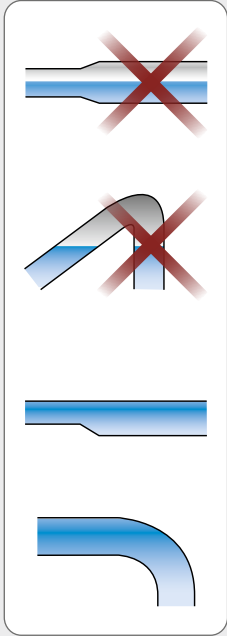



3

JP / JP PM / JP PT-V / JP PT-H

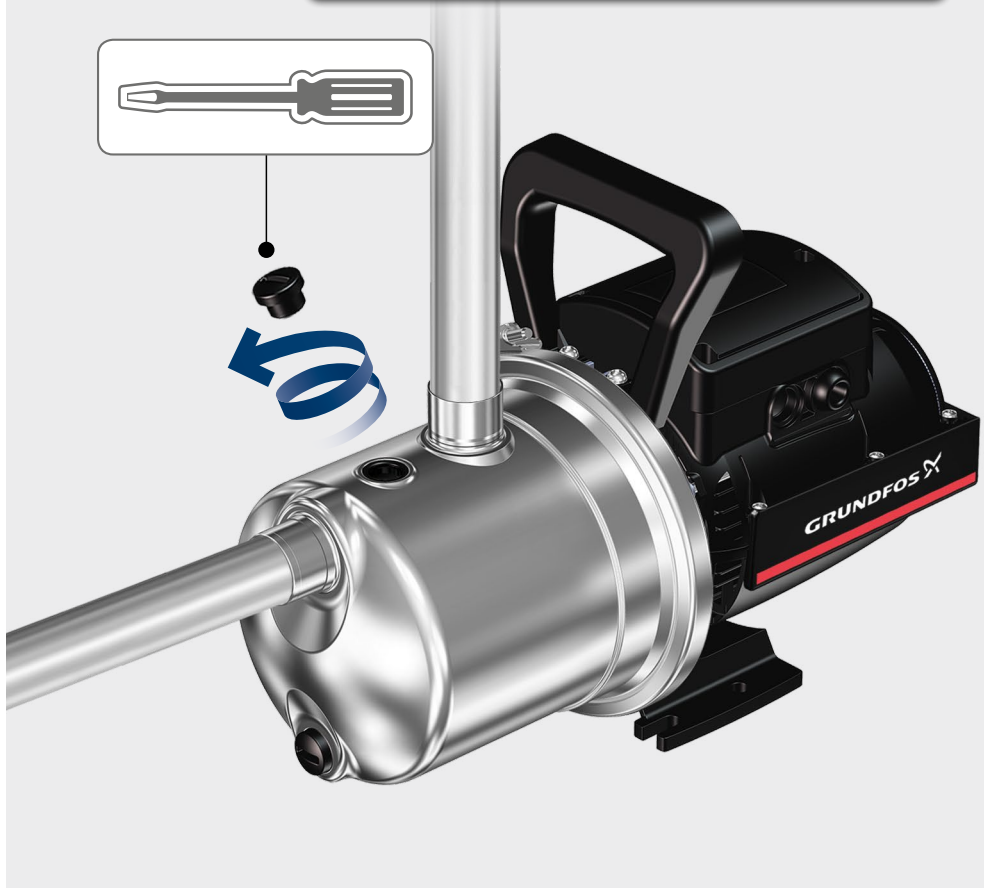

4

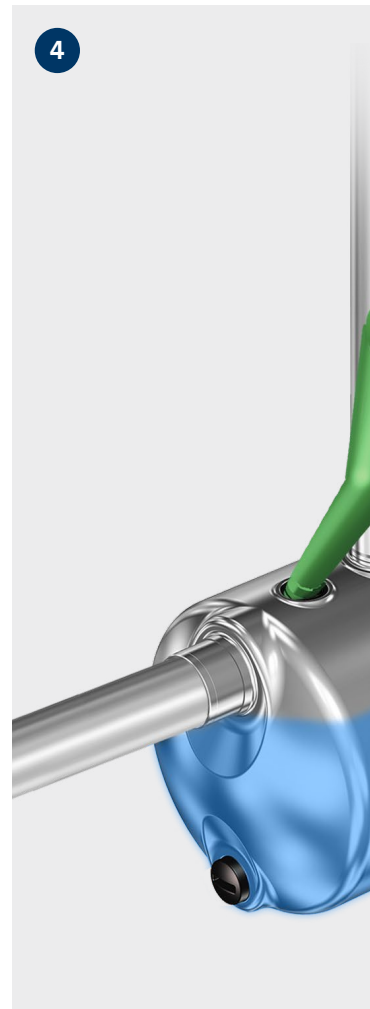



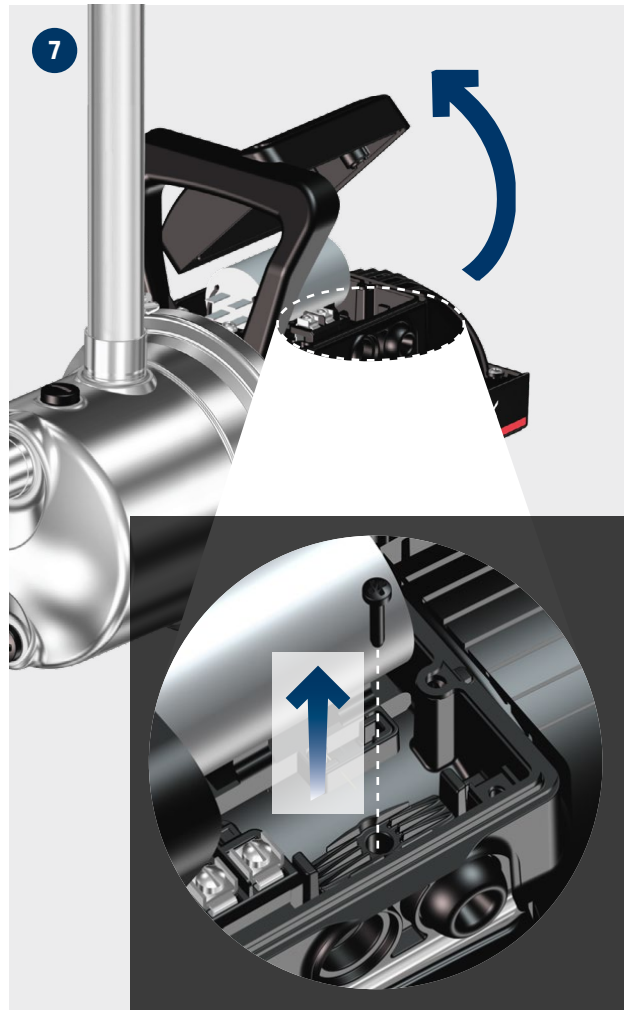

JP / JP PM / JP PT-V / JP PT-H



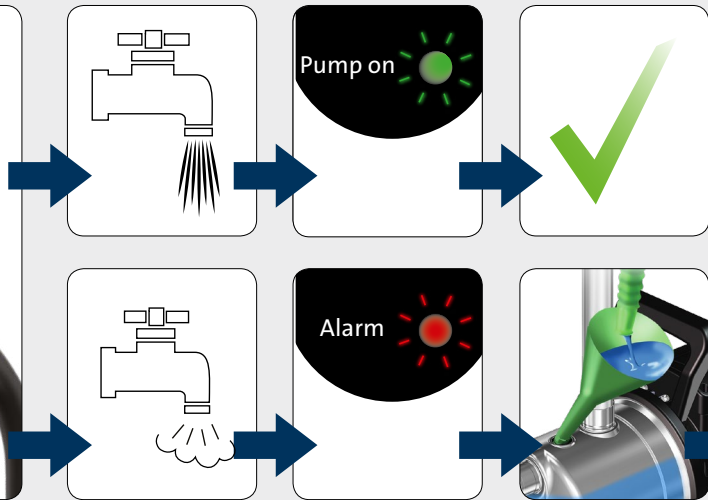
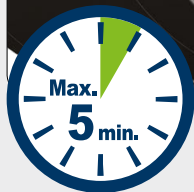

JP PM

Reset



JP / JP PM / JP PT-V / JP PT-H

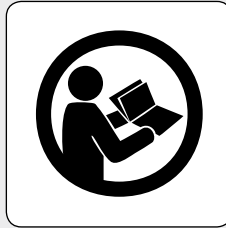

be think innovate

Installation date: _____

Installer:

99544277 1218

ECM: 1249679

GRUNDFOS Holding A/S
Poul Due Jensens Vej 7
DK-8850 Bjerringbro
Tel: +45 87 50 14 00

GRUNDFOS 

Trademarks displayed in this material, including but not limited to Grundfos, the Grundfos logo and "be think innovate", are registered trademarks owned by The Grundfos Group. All rights reserved.
© 2018 Grundfos Holding A/S, all rights reserved.